

# HADES

---

Staging yard control for analogue  
and digital model railway layouts

Manual

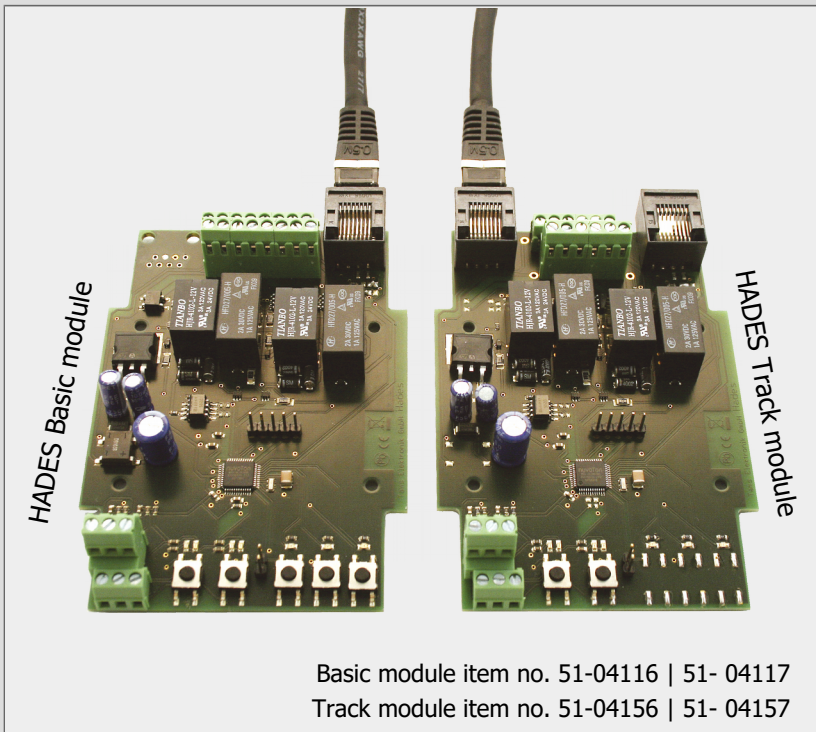

**Version: 2.0 | Status: 10/2022**

**© Tams Elektronik GmbH**

All rights reserved, in particular the right of reproduction, distribution and translation. Copies, reproductions and alterations in any form require the written permission of Tams Elektronik GmbH. We reserve the right to make technical changes.

**Printing the manual**

The formatting is optimised for double-sided printing. The standard page size is DIN A5. If you prefer a larger display, printing on DIN A4 is recommended.

## Contents

1. Getting started.....	5
1.1. Contents of the package.....	5
1.2. Accessories.....	6
1.3. Intended use.....	7
1.4. Safety instructions.....	7
1.5. Care.....	7
2. Your staging yard control HADES.....	8
2.1. Possible applications.....	8
2.2. Components.....	8
2.3. Concept of a staging yard with HADES.....	9
2.4. Modes of operation.....	10
2.5. Procedure.....	11
2.6. Operation elements and displays.....	13
2.7. Malfunction.....	14
2.8. Power supply.....	14
3. Setting-up the staging yard.....	15
3.1. Sidings.....	15
3.2. Turnouts.....	16
3.3. Transit track or stopping section.....	16
4. Connections.....	17
4.1. Connecting the basic module.....	17
4.2. Connecting the track modules.....	19
4.3. Connecting the entry turnouts.....	21
4.4. Interconnecting basic and track modules.....	22
4.5. Connecting an external on/off switch.....	23
4.6. Connecting external exit buttons and status LEDs.....	23
4.7. Setting up a stopping section at the entrance to the staging yard.....	25
5. Operation.....	27
5.1. Operation and displays.....	27
5.2. Malfunctions and fault messages.....	28
5.3. Setting the departure time.....	29

---

6. Checklist for troubleshooting and error correction.....	30
6.1. Fault messages on the LEDs.....	30
6.2. Malfunctions in the sequence.....	30
6.3. Technical Hotline.....	31
6.4. Repairs.....	31
7. Technical data.....	32
8. Warranty, EU conformity & WEEE.....	34
8.1. Guarantee bond.....	34
8.2. EU Declaration of Conformity.....	35
8.3. Declarations on the WEEE Directive.....	35

## 1. Getting started

The instructions will help you step by step with the safe and proper installation and use of your staging yard control. Before you put the module(s) into operation, read this manual completely, especially the safety instructions and the section on possible errors and their elimination. You will then know what you have to pay attention to and thus avoid errors that sometimes can only be rectified with a lot of effort.

Keep the instructions in a safe place so that you can restore functionality later in the event of any malfunctions. If you pass the module(s) on to another person, also give the instructions with it.

### 1.1. Contents of the package

**Basic module** (item no. 51-04116-01 or 51-04117-01)

- 1 ready-built and tested circuit board (without housing) or  
1 HADES basic module in housing
- 1 short circuit jumper 2-pole, RM 2.54

**Track module** (item no. 51-04156-01 or 51-04157-01)

- 1 ready-built and tested circuit board (without housing) or  
1 HADES track module in housing
- 1 short circuit jumper 2-pole, RM 2.54
- patch cable (RJ 45)

## 1.2. Accessories

### Connection cables

The use of stranded wire is recommended for the connections. Stranded wires consist of several thin individual wires and are therefore more flexible than rigid wires with the same copper cross-section.

Connection to	Recommended cross-section
Power supply, tracks and turnouts	$\geq 0.25 \text{ mm}^2$
Push-buttons, switches, LEDs	$\geq 0.04 \text{ mm}^2$

### External push-buttons and indicator LEDs (optional)

You can manually trigger the exit of the trains from the tracks via additional external push-buttons and/or have the occupancy status of the tracks displayed on additional, external LEDs. You then need **per siding**:

- one push-button 1 x make contact (e.g. item no. 84-5211x or 84-5212x )
- one red and one green LED and one series resistor per LED ( $\geq 120 \text{ Ohm}$ )

### Set up a stopping section at the entrance to the staging yard (optional)

For this you need

- a bistable relay 12 V (e.g. item no. 84-61111). Note: If you want to control a semaphore signal together with the stop section, a bistable relay 1xUm is sufficient, for simultaneous control of a light signal you need a bistable relay 2xUm.
- or a relay circuit board RL-2 (kit item no. 72-00055-01 or ready-made module item no. 72-00056-01)
- and, if necessary, a entry signal without train control.

As an alternative to using a relay, you can directly connect an entry signal with train control.

### Using motor-driven turnouts or turnouts with servo drive (optional)

If you do not use turnouts with double coil drives as entry turnouts, you will need additional circuits that enable the turnouts to be switched by means of switching pulses:

- for motor-driven turnouts: adapter AMW-1 (item no. 72-00076-01) or AMW plus (item no. 72-00176-01)
- for turnouts with servo drive: SD-32 servo decoder for analogue or digital control (ready-made module item no. 43-00326-01 or ready-made device item no. 43-00327-01)

### 1.3. Intended use

The staging yard control HADES is intended for use in digital model railway layouts as specified in the instructions. Any other use is not in accordance with the intended use and will result in the loss of the warranty claim. Intended use also includes reading, understanding and following all parts of the instructions. The staging yard control HADES is not intended to be used by children under the age of 14.

### 1.4. Safety instructions

**Note:**

The modules contain integrated circuits (ICs). These are sensitive to electrostatic charging. Therefore, do not touch these components until you have "discharged" yourself. For this purpose, e.g. a grip on a radiator is sufficient.

Improper use and non-observance of the instructions can lead to incalculable hazards. Prevent these dangers by carrying out the following measures:

- Only use the staging yard control in closed, clean and dry rooms. Avoid moisture and splash water in the environment. After condensation has formed, wait two hours for acclimatisation before use.
- Disconnect the modules from the power supply before carrying out wiring work.
- Supply the unit only with extra-low voltage as specified in the technical data. Use only tested and approved transformers.
- Only plug the mains plugs of transformers into properly installed and fused earthed sockets.
- When making electrical connections, ensure that the cable cross-section is sufficient.
- Heating of the modules during operation is normal and harmless.
- Do not expose the modules to high ambient temperatures or direct sunlight. Observe the information on the maximum operating temperature in the technical data.
- Regularly check the operational safety of the modules, e.g. for damage to the connection cables.
- If you notice damage or if malfunctions occur, disconnect the connection to the power supply immediately. Send the module(s) in for inspection.

### 1.5. Care

Do not use any cleaning agents to clean the modules. Only wipe the modules dry. Disconnect the modules from the power supply before cleaning.

## 2. Your staging yard control HADES

HADES supervises and controls the activities in a staging yard with

- 2 to 32 sidings
- and one transit track *or* a stopping section at the entrance to the staging yard.

### 2.1. Possible applications

HADES works independently from the rest of the layout control system and can therefore be used in analogue DC or AC layouts as well as in all digital layouts.

In principle, HADES is suitable for all nominal sizes. The maximum switching current of the relays that switch the track voltage for the sidings is 3 A. Therefore, the maximum current of a train in a siding must not exceed 3 A.

HADES has a connection for an external on/off switch that switches to ground. As long as this switch is closed, it is impossible to trigger a train exit from one of the sidings. This makes it possible, for example, to integrate the staging yard controlled by HADES into a block station control.

### 2.2. Components

HADES has a modular structure and consists of

- a basic module for monitoring and controlling 2 sidings as well as a transit track or a stopping section at the entrance to the staging yard,
- additionally up to 15 track modules for two further sidings each. The last track module can be configured to monitor and control only one siding.

Basic and track modules are connected to each other via patch cables.

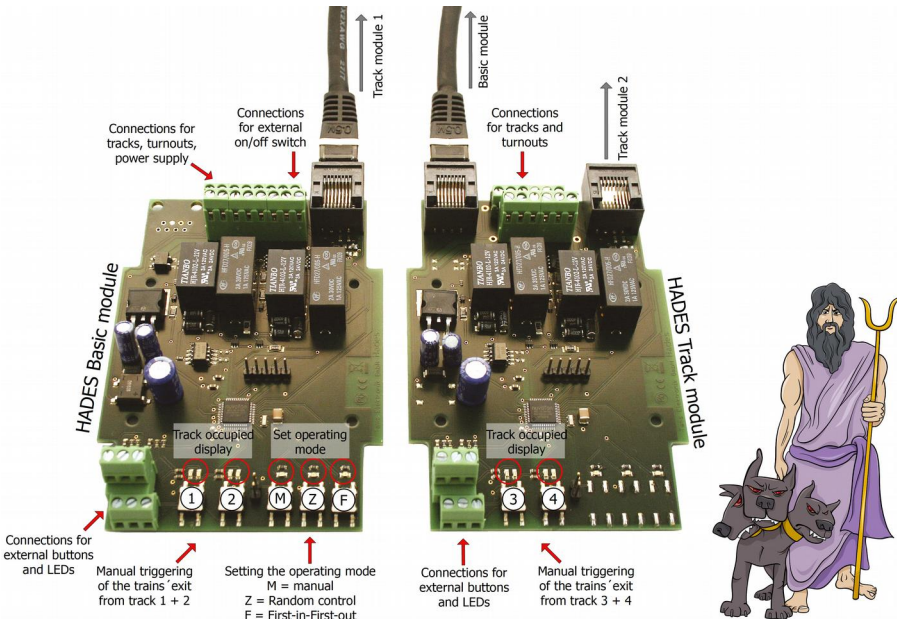



## 2.3. Concept of a staging yard with HADES

### Number of sidings

The number of sidings in the staging yard is at least 2 and at most 32. An uneven number of sidings in the staging yard is possible. For this purpose, a jumper is attached to the last track module and this track module is thus configured for the monitoring of a single siding track.

### Security

In order to prevent accidents caused by further arriving trains when all sidings in the staging yard are occupied, you can either

- install a transit track allowing incoming trains to drive through directly or
- install a stopping section at the entrance to the staging yard, where trains wait until a siding has been cleared. The entry signal for the staging yard can be controlled commonly with the stopping section.

### Example 1:

#### Staging yard with 6 sidings and one transit track

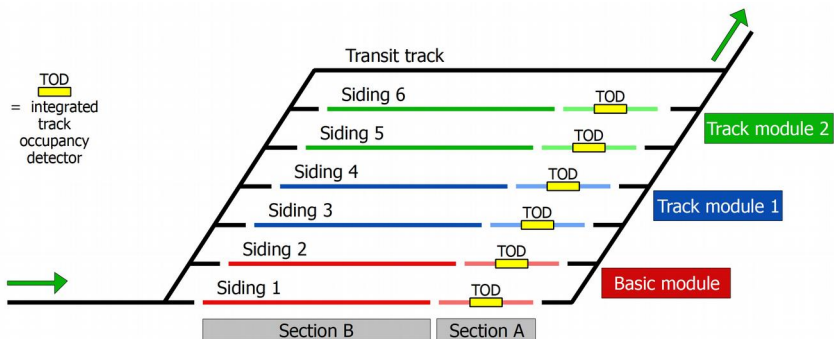

### Example 2:

#### Staging yard with 6 sidings and a stopping section at the entrance

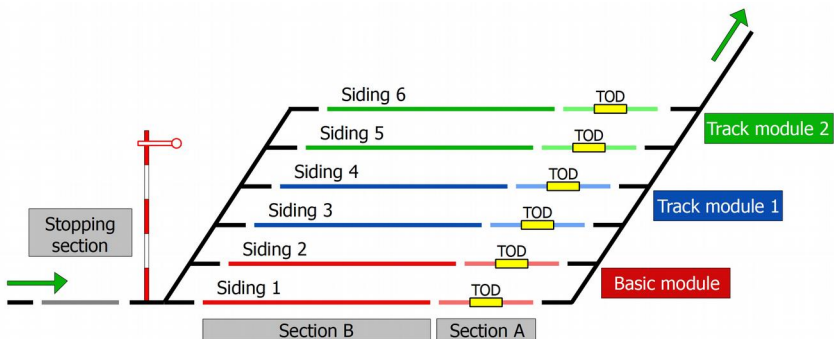

### **Track sections**

The sidings have to be separated electrically from the rest of the layout. HADES works comparably to switches to switch on and off the track voltage for the sidings. As long as a siding has not been switched off by HADES, the train reacts to switching and driving commands of the (analogue or digital) layout control unit.

All sidings have to be divided into two sections (A and B). The sections must have the following minimum lengths:

- Section A: at least as long as the longest locomotive or driving trailer
- section B: at least as long as the longest train including locomotive

As it is not possible to direct an incoming train to a specific siding, all sidings must have these minimum lengths.

### **Entry and exit turnouts**

HADES sets the turnouts at the access to the sidings according to the operating principle of push-buttons. Turnouts with double coil drive can be directly connected as entry turnouts. In order to control motor-run or servo-driven turnouts you need additional control devices (see chapter 1 "Accessories").

The exit turnouts are forced open when a train is departing from the staging yard. For that reason you have to use turnouts not blocking to be forced open.

## **2.4. Modes of operation**

The following operating modes can be selected with the help of buttons located on the basic module:

- First-in-first-out: An incoming train releases the departure of the train which is in the staging yard for the longest time. Consequently, the order of the arriving trains is maintained.
- Random control: An incoming train releases the departure of an arbitrary train.
- Manual control: Pressing a push-button releases the departure of the train on the assigned siding.

Even if one of the two automatic operating modes "First-in-First-out" or "Random control" is set, it is always possible to manually trigger the exit of a train from a specific track.

The operating mode set in each case is saved and set again the next time the system is switched on.

## 2.5. Procedure

After switching on or after a restart, HADES first checks

- the number of connected track modules;
- whether the last track module monitors and controls one or two sidings;
- whether sidings are occupied or free.

If vehicles have been manually removed from a siding or parked there in the switched-off state, HADES sets the entry turnouts according to the current occupancy status.

### Phase 1

The entry turnouts of all free sidings are switched to "branch" (into the siding). An arriving train therefore enters the first free siding (seen in the direction of travel). For all free sidings, section A is de-energised, section B is energised.

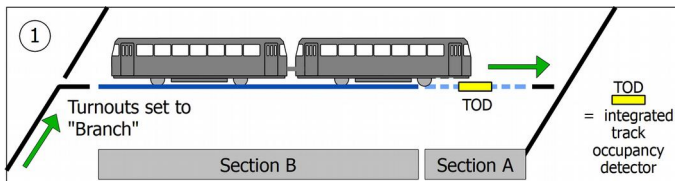

### Phase 2

As soon as the integrated track occupancy detector detects a power consumer (locomotive, illuminated wagon) in section A, section B of the siding is also de-energised. The train stops, all consumers (e.g. lighting) are switched off. When the train enters the siding, it does not matter whether the locomotive pulls or pushes the train. The only thing that is essential for the control to function is that there is a power consumer (e.g. a light) at the end that enters section A. The power is switched off at the same time as the train enters the siding.

At the same time as the power is switched off in the siding, the entry turnout is set to "through". Subsequent trains can then no longer enter this track.

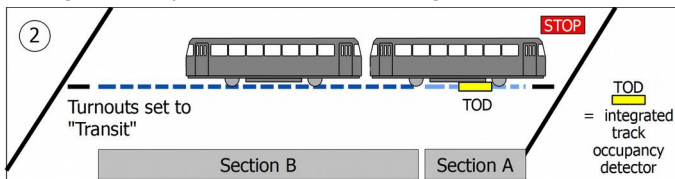

### Phase 3

The departure of a train from a siding is released, as soon as

- another train is arriving in the staging yard (with automatic operation modes "random control" or "first-in-first-out" set)
- or the push-button assigned to the siding is pressed (in all operation modes).

Then the current is switched on in both track sections (A and B). When departing from the staging yard, the train cuts open the turnout.

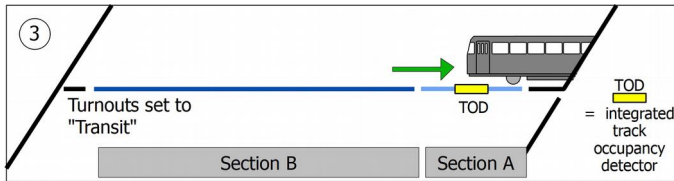

The departure of a train is blocked, when

- the switching contact of an external on/off switch is closed,
- a train has just departed from another track (and the set departure time\* has not yet run out),
- HADES has interrupted the operation due to malfunction.

### Phase 4

After the integrated track occupancy detector no longer detects a consumer in the track after the departure time\* has expired, section A is de-energised again and the entry turnout is set to "branch" (into the siding).

In case a (control) carriage with own current collector tears off during departure, the occupancy message remains after the departure time\* has run out. HADES detects the fault and freezes the operation in the staging yard.

Hint: in 2-rail systems carriages without current collector are detected, if the axles are painted with resistive varnish or a resistor (approx. 10 kOhm) is soldered between the two wheels that pick up current.

### \*Departure time

The departure time is set in common for all tracks. It defines the period of time that elapses after releasing the departure of a train from a siding, before

- the departure of the next train is possible,
- HADES defines a track occupancy signal from the track in question as a "fault" (due to a current consuming carriage probably having been torn off),
- the entry turnout is set to "branch" into the siding.
- the current for track section A is switched off.

The departure time can be set to a time between 2 and 20 seconds (in 1 second steps). In state of delivery the departure time is set to 5 seconds. You can always alter the setting during ongoing operation.

## 2.6. Operation elements and displays

### Selecting the operation mode

You select one of the operating modes

- manual control,
- random control or
- first-in-first-out

with the push-buttons on the basic module. A LED shows which operation mode has been set.

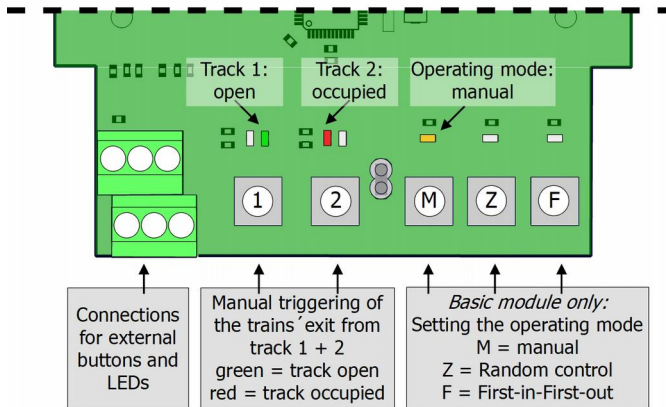

### Manual triggering of train departure

On each (base or track) module there are two buttons with which the departure of a train from the two associated sidings can be triggered manually. Red and green LEDs indicate whether the two tracks are occupied or free.

In addition to the exit push-buttons and busy occupancy LEDs on the modules, external buttons and LEDs can be connected. These buttons and LEDs can be built into a track diagram control panel, for example.

## 2.7. Malfunction

HADES detects faults possibly causing accidents in the staging yard:

- failure of the track voltage (e.g. when a short circuit has occurred on the layout)
- remaining carriage (with current collector) in a sliding
- failure of a track module

HADES stops the operation as soon as a fault is detected. Faults are displayed at LEDs on the modules (→ section 5.2).

When a voltage failure occurs, all as-is states (occupancy signals, positions of turnouts) are "frozen", in order to restart operation with the present settings as soon as the track voltage is applied again. In case the malfunction is not caused by a voltage failure, a restart is required after having eliminated the cause of the fault.

## 2.8. Power supply



### Note:

HADES has to be supplied by a transformer **not** in use as an (analogue) driving transformer or for supplying the digital system. If HADES is supplied by a transformer used as an (analogue) driving transformer or for supplying the digital system as well, short circuits possibly occur in the circuit leading to irreparable damages.



### Note:

Analogue driving transformers with an extra connection for accessories ("lighting") beside the connection for the track are **not** suitable for the common supply of rails and circuit. These types of transformers are internally built of one transformer only!

**Hint:** It is possible to supply HADES by a transformer in use to supply other accessories (e.g. lightings).

### 3. Setting-up the staging yard

#### 3.1. Sidings

##### Number of sidings

The number of sidings in the staging yard is 2 to 32. The basic module and the track modules can monitor and control 2 sidings each. If you need an odd number of sidings, you can configure the last track module to monitor and control only one track section.

##### Minimum lengths

All sidings must have the following minimum length:

- length of the longest locomotive or the longest (control) car (section A)
- + length of the longest train (section B)

##### Electrical separation of the sidings

The sidings must be electrically separated at the following points:

- directly behind the entry turnout (seen in direction of travel)
- directly before the exit turnout (seen in the direction of travel)
- between sections A and B of the siding

To do this, disconnect

- the centre conductor in the case of 3-conductor systems or

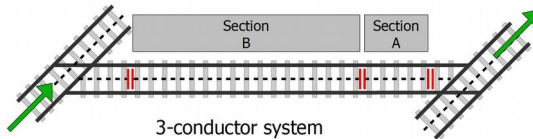

- the **left** rail as seen in the direction of travel in the case of 2-conductor systems.

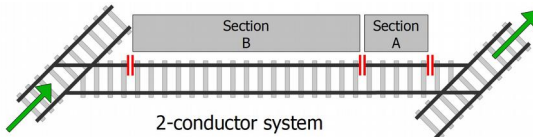

## 3.2. Turnouts

You can use the following as entry turnouts:

- coil-driven turnouts: without any additional components
- motor-run turnouts: in combination with adapter AMW-1 or AMW plus
- servo-driven turnouts: in combination with additional modules controlling servos (e.g. servo decoder SD-32).

The exit turnouts must allow to be cut open by departing trains.

## 3.3. Transit track or stopping section

In order to prevent accidents when all sidings are fully occupied, you have to choose one of two safety measures:

- Transit track: An incoming train first has to pass all entry turnouts leading to the sidings before it directly departs from the staging yard when all sidings are occupied.
- Stopping section at the entrance to the staging yard: The section is switched currentless when all sidings are occupied. If you want to install a stop signal in front of the stopping section, you can switch it together with the stop section.

Examples → Section 2.3

- Example 1: Staging yard with 6 sidings and one through track
- Example 2: Staging yard with 6 sidings and a stopping section at the entrance



## 4. Connections

There are terminal strips soldered to basic and track modules which are used to insert and screw on the connecting cables.

### Connection cables

The use of stranded wire is recommended for the connections. Stranded wires consist of several thin individual wires and are therefore more flexible than rigid wires with the same copper cross-section.

Connection to	Recommended cross-section
Power supply, tracks and turnouts	$\geq 0.25 \text{ mm}^2$
Push-buttons, switches, LEDs	$\geq 0.04 \text{ mm}^2$

### 4.1. Connecting the basic module

1   2	<p>Voltage supply for HADES. The polarity of the connections is of no importance.</p> <div style="border: 1px solid black; padding: 5px;"> <p> <b>Do not use</b> the (analogue) driving transformer or the transformer supplying the digital system!</p> </div>
3   4	<p>Rails outside the staging yard</p> <p>3 = separated conductor with 2-rail-systems: left rail with 3-rail systems: centre conductor</p> <p>4 = continuous conductor with 2-rail-systems: right rail with 3-rail systems: outer conductor</p>
5	Siding 2 / Track section A
6	Siding 1 / Track section A
7	Siding 2 / Track section B
8	Siding 1 / Track section B
9   11   13	Entry turnout 2 (for siding 1)   11 = return conductor Connection entry turnout → Section 4.3.
10   12   14	Entry turnout 1 ( for siding 2)   12 = return conductor Connection entry turnout → Section 4.3.
15   16	External on/off switch (e.g. for integration into block station control) 15 = GND   16 = IN → Section 4.5.

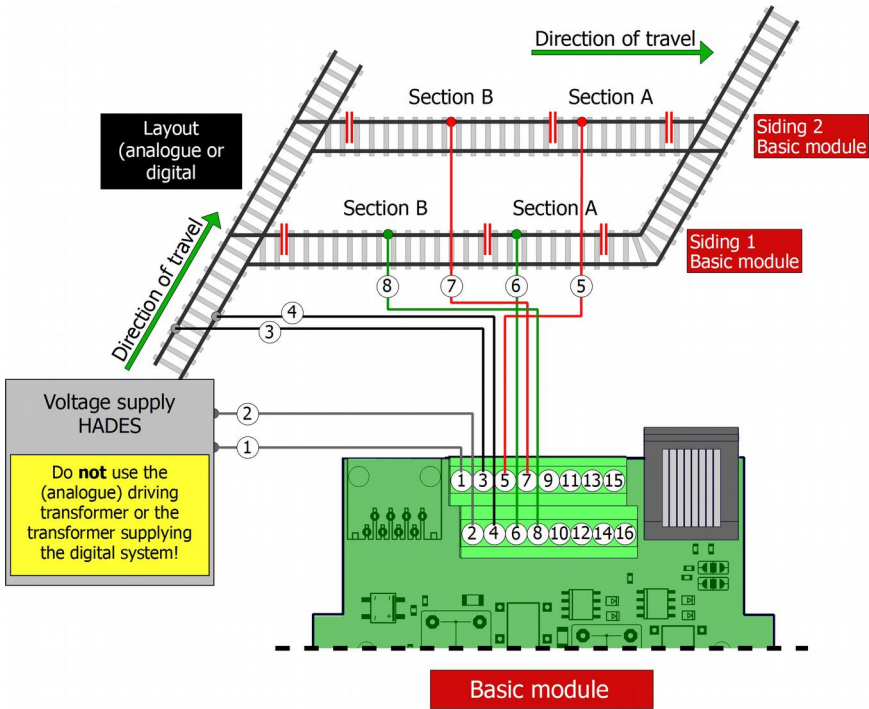

**Basic module:**

Connecting the voltage supply, the sidings and the rails outside the staging yard  
Connecting the entry turnouts → Section 4.3.

## 4.2. Connecting the track modules

1   2	not equipped
3   4	3 = separated conductor with 2-rail-systems: left rail with 3-rail systems: centre conductor 4 = not in use
5	Siding 2 / Track section A (optional*)
6	Siding 1 / Track section A
7	Siding 2 / Track section B (optional*)
8	Siding 1 / Track section B
9   11   13	Entry turnout 2 (for siding 2 / optional*)   11 = return conductor Connection entry turnout → Section 4.3.
10   12   14	Entry turnout 1 (for siding 1)   12 = return conductor Connection entry turnout → Section 4.3.
15   16	not equipped

### \* Configuration for an odd number of sidings

It is possible to configure the last track module that way, it supervises and controls only one siding (with an uneven number of siding in the staging yard). For this purpose you have to set a jumper to the pin strip marked in the illustration.

Connections 5 and 7 (siding 2 of the relevant track module) as well as 9, 11 and 13 (entry switch 2 of the relevant track module) will then remain free.

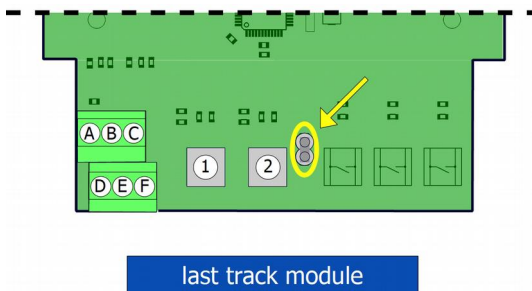

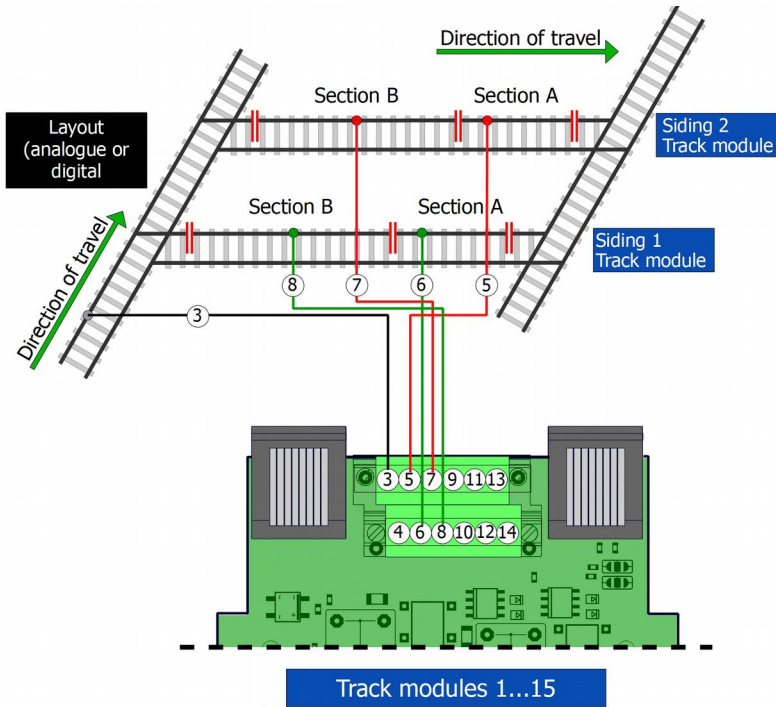

### Track module:

Connecting the sidings and the rails outside the staging yard  
 Connecting the entry turnouts → Section 4.3.

### 4.3. Connecting the entry turnouts

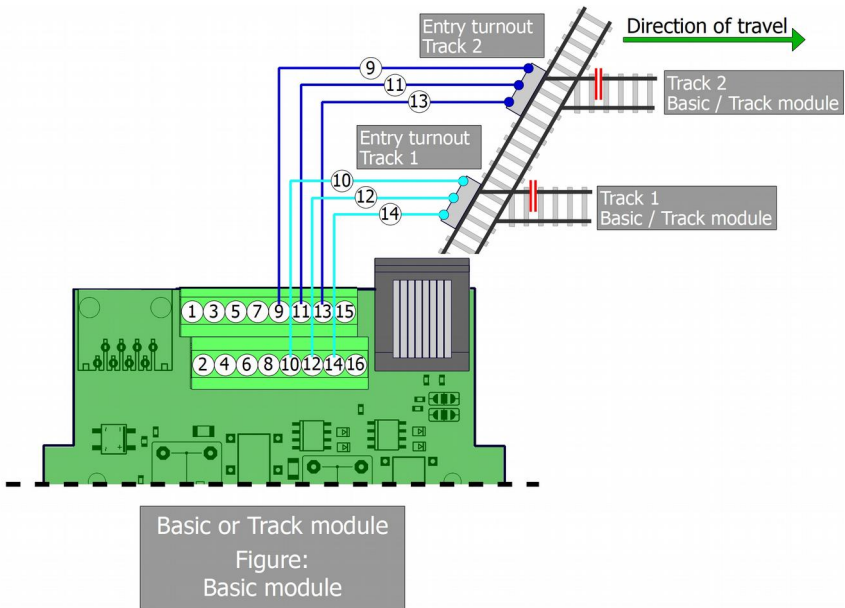

#### Odd number of sidings

If there is an odd number of sidings in the staging yard, the last track module will be configured to monitor and control only one siding (see section 4.2.). Connections 5 and 7 (siding 2 of the relevant track module) as well as 9, 11 and 13 (entry switch 2 of the relevant track module) will then remain free.

#### Testing the functionality of the turnouts

Always test after connecting the turnouts to base or track modules whether they are fully functional and "correctly" switched, i.e.

- with occupied track on "through" (in the direction of the through track or exit),
- if the track is free, to "branch" (in the direction of the siding).

#### **Caution:**

The correct connection of the entry turnouts and the reliable function of the turnouts are decisive for the safe function of the control system! In case of malfunctions, entering trains can cause accidents!

### Connection of turnouts with turnout lanterns

With some types of turnouts, the turnout lanterns are electrically connected to both the rails and the turnout drives in order to switch the lanterns together with the turnouts. If you want to use such turnouts as entry turnouts for the staging yard, you have to electrically disconnect the turnout lanterns from the turnout drives.

#### ! Caution:

Turnout lanterns that are electrically connected to the turnout drives can cause electrical disturbances and thus endanger the safe operation of the staging yard. These electrical disturbances can also cause damage to the modules, which in the worst case is irreparable.

### 4.4. Interconnecting basic and track modules

For the connection of basic and track modules RJ 45 cables are used. In order to connect the first track module to the basic module you have to insert the cable into the RJ 45 socket beside terminal strips 3 and 4 (not into the socket beside terminal strips 13 and 14). Connect further track modules to the previous track module in the same way.

#### ! Caution:

Always disconnect the voltage supply for the basic module before inserting or disconnecting a RJ 45 cable. Otherwise components on the modules possibly are damaged!

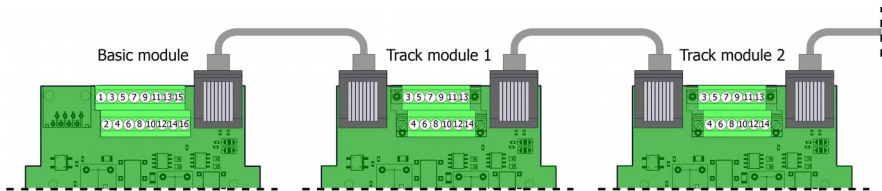

Pay attention to not connecting the modules "crosswise" – especially with track modules not mounted side by side.

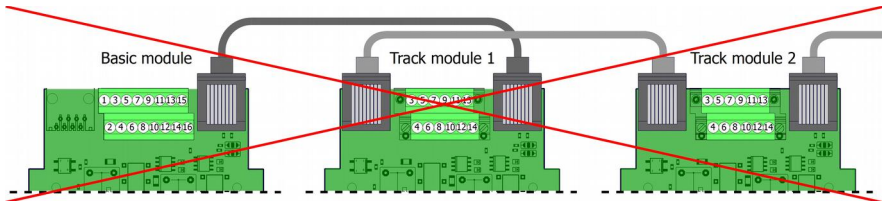

## 4.5. Connecting an external on/off switch

The basic module has a connection for an external switch or an external control module working according to the principle of switches (terminal strips 15 and 16). This allows, for example, to integrate the staging yard into a block-control management.

As long as the switch is closed (= IN connected to earth), the departure of trains from the sidings is blocked, regardless of the set operation mode. After the switching contact has been opened, the departure of that train is released which was blocked first. Further switching pulses which were released while the switch was closed, will be rejected.

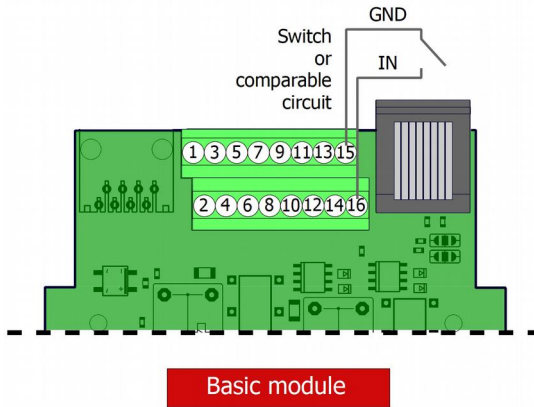

## 4.6. Connecting external exit buttons and status LEDs

In addition to the buttons and LEDs on the modules, you can connect to each module

- 2 external buttons for manually triggering the exit of trains and/or
- 2 red and 2 green LEDs each as indicators "free" / "occupied".

You can integrate the external buttons and LEDs e.g. into a track diagram control panel.

### Connection of external exit push-buttons

Use push buttons that close the circuit when actuated (1 x normally open contact) and return to the initial position after being actuated again.

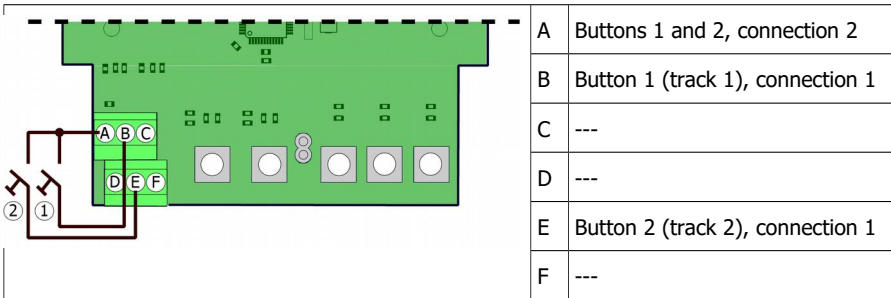

### Connecting external status LEDs

The circuit provides the current for the LEDs. A constant voltage of 5 V is applied to the outputs, which is not sufficient for the operation of lamps.

The value of the series resistor must be at least 120 ohms. This value is designed for the use of red and green standard LEDs (forward voltage = 2 V, luminous intensity = 50 - 100 mcd). If you use LEDs with a different forward voltage and/or a significantly higher brightness, you must re-determine the series resistor values.

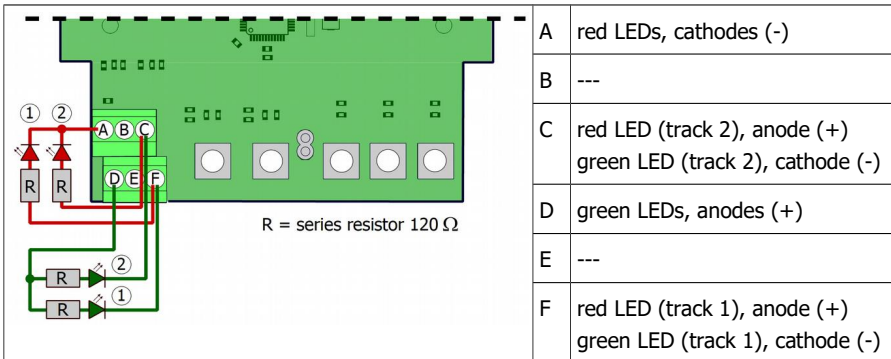

#### ⚠ Connect each LED via its own series resistor!

Otherwise, the LEDs will only achieve a shortened service life. In addition, damage to the outputs of the circuit is possible!





## Use of a signal with integrated track influence

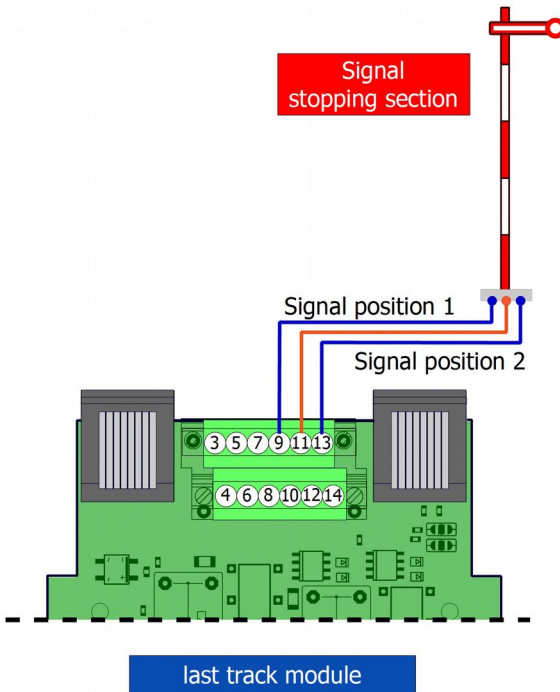

If you are using a signal that has track influence built in, connect the signal directly to terminals 9, 11 and 13 of the track module. Connect the track in the stopping section according to the specifications of the signal manufacturer.

## 5. Operation

### 5.1. Operation and displays

#### Choosing the operation mode

Set one of the operation modes:

- manual operation
- random operation
- first-in-first-out

on the push-buttons of the basic module. The set operation mode is displayed on the associated LED.

Please note: When the automatic modes "random operation" or "first-in-first-out" are set, the departure of a train is released every time after a train has come in.

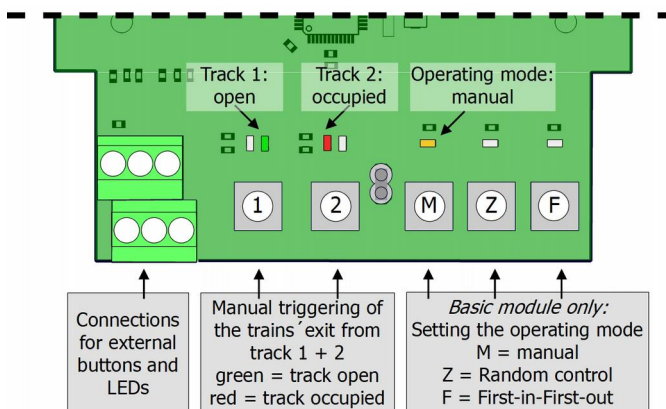

#### Manually triggering the departure of a train

Two push-buttons on the basic or track modules (or two additionally connected push-buttons) allow to trigger the departure of a train at any time. The assigned red and green LEDs show whether the sidings are occupied or not.

#### Restarting HADES

In order to restart HADES, you can either

- switch the power supply off and on again or
- hold down the buttons M and Z simultaneously for approx. 1 second.

A restart is required when HADES has detected an error which requires user intervention to be remedied.

During a restart, HADES checks

- the number of connected track modules
- if the last track module monitors and controls one or two sidings
- whether sidings are occupied or free

If vehicles have been manually removed from a siding or parked there in the switched-off state, HADES sets the entry turnouts according to the current occupancy status.

## 5.2. Malfunctions and fault messages

HADES detects malfunctions that can lead to accidents in the staging yard and then stops operation. The causes of the faults are indicated on LEDs on modules.

### Failure of the track voltage (e.g. after a short circuit)

All states (track occupancy messages, positions of turnouts) are automatically "frozen".

Display	Basic module: The red and green LEDs for track 2 light up simultaneously
Continuation of operation	As soon as the track voltage is applied again, operation continues automatically without further interruption with the previous settings.

### Remaining of a wagon in the siding

HADES detects a fault if a vehicle (with current consumption) is still in the siding after the set departure time (→ section 5.3.) has elapsed. If the fault is not due to a wagon that has broken off, you must adjust the departure time (→ section 5.3.)

Display	Base or track modules: The red and green LEDs for the occupied/ vacant display of the relevant track flash alternately.
Continuation of operation	After removing the wagon, a restart must be carried out.

### Failure of a track module

HADES recognises a malfunction if a track module no longer responds to the queries carried out at intervals of approx. 0.5 seconds. Causes can be a defect in the module or a loosened connection between base and track module.

Display	Basic module: The three LEDs used to indicate the set operating mode produce a running light.
Continuation of operation	After rectifying the fault, a restart must be carried out.

### 5.3. Setting the departure time

In state of delivery, the departure time is set to 5 seconds, which normally allows an unobstructed operation. The set time always is valid for all tracks. You can adapt the time (in 1 second-steps) to a time between 2 and 20 seconds.

In the following cases you have to adapt the time:

- While a train is still departing from a siding, track section A is already switched currentless or HADES detects an error (due to a supposed torn off carriage). In this case you have to prolong the departure time.
- Although a train has departed from the siding already some time ago, the entry turnout is not set to "diverging" into the siding. In this case you have to shorten the departure time. Please note: Especially when trains are incoming into the staging yard at frequent intervals, a too long departure time possibly causes malfunction.

You can adapt the departure time at any time during ongoing operation. Proceed as follows:

- Press push-button "Z" (cor choosing random operation) at the basic module and hold it.
- In order to shorten the departure time by 1 second: Press push-button "exit from siding 1" at the basic module shortly or
- In order to prolong the departure time by 1 second: Press push-button "exit from siding 2" at the basic module shortly

The module acknowledges having recieved the setting by changing the status of the LED for operation mode "Z" (from "on" to "off" or reverse).

As soon as you release push-button "Z", the LED for operation mode "Z" changes to the initial status.

Hint: You can shorten or prolong the departure time by 1 second at a time. If you want to make further adaptions, you have to repeat the procedure.

## 6. Checklist for troubleshooting and error correction

 **Warning:** If you notice a strong heat development, immediately disconnect the basic module from the supply voltage. **Fire hazard!** Send in the basic module and all track modules for testing.

### 6.1. Fault messages on the LEDs

- Both LEDs on the basic module normally showing the status of occupancy for siding 2 light simultaneously.  
Possible cause: The track voltages has failed (e.g. due to a short circuit).  
→ Switch the track voltage back on (after rectifying the short circuit). Operation restarts automatically with the previous settings.
- The two LEDs normally showing the status of occupancy on a basic or track module flash alternately.  
Possible cause: one or several carriages have been torn off during the train's departure.  
→ Check the related siding.  
Possible cause: The departure time has been set too short.  
→ Prolong the departure time.  
After having eliminated the error, you have to restart HADES.
- The LEDs on the basic module normally showing the set operation mode, display a sequential light.  
Possible cause: A track module could not be detected (no longer).  
→ Check if all patch cables connecting basic and track modules are inserted properly.  
→ Check if all track modules are working (e.g. by setting a locomotive on a siding and checking the occupancy LED for the siding).  
After having eliminated the error, you have to restart HADES.

### 6.2. Malfunctions in the sequence

- After a train has arrived, the siding is not shown as "occupied" and/or the entry turnout has not switched.  
Possible cause: In analogue d.c. layouts the (in direction of travel) right rail has been cut off instead of the left one.  
→ Check the cuts.
- An incoming train passes without stopping in the siding. A pushed train does not stop in time.  
Possible cause: Section A and / or section B of the siding have not been isolated electrically from the rest of the layout.  
→ Check the cuts.  
Possible cause: The siding has not been connected properly.  
→ Check the connections.

- With all sidings occupied HADES stops operation.  
Possible cause: The jumper at the basic module has been set (and thus a stopping section at the staging yard's entrance has been configured), actually there is a transit track available.  
→ Check if the jumper has been set and remove it.
- In automatic mode (first-in-first-out or random operation) an incoming train does not release the exit of train.  
Possible cause: There is only one siding connected to a track module, but the jumper has not been set.  
→ Insert the jumper.
- After having pressed the departure button, the train does not depart from the siding.  
Possible cause: The external on/off switch has been closed, which in general blocks the departure of trains.  
→ Check the position of the switch.  
Possible cause: The departure time for another siding has not run out yet.  
→ Check (and adapt) the settings for the departure time.  
Possible cause: HADES has "frozen" the operation.  
→ Check if the LEDs on the basic or track modules show an error.

### 6.3. Technical Hotline

If you have any questions about the use of the staging yard control, our technical hotline will help you (telephone number and e-mail address on the last page).

### 6.4. Repairs

You can send us defective modules for repair (address on the last page). In the event of a warranty or guarantee claim, the repair is free of charge for you. As proof of any warranty or guarantee claim, please enclose the proof of purchase with your return.

If there is no warranty or guarantee claim, we are entitled to charge you the costs of the repair and the costs of the return shipment. We charge a maximum of 50% of the new price for the repair according to our valid price list. We reserve the right to refuse the repair if it is technically impossible or uneconomical.

If you want to clarify whether a repair is possible or economical before sending it in, please contact our Technical Hotline (telephone number and email address on the last page).

Please do not send us repair shipments freight collect. In the event of a warranty or guarantee claim, we will reimburse you for the regular shipping costs.

## 7. Technical data

### Interfaces, outputs and inputs

Connection of further modules	Basic module: 1 x RJ45 Track module: 2 x RJ 45
Outputs	Entry turnouts: 2 per module for direct connection of turnouts with double coil drive for connection of motor-run turnouts or turnouts with servo drive: additional controllers required Sidings: 2 per module 2 separate track sections per siding, one of which has an integrated track occupancy detector
Outputs (use optional)	2 for 4 external occupancy indicator LEDs per module Supply voltage: 5 V constant
Inputs (use optional)	2 inputs for external exit push-buttons per module 1 input for external on/off switch or comparable circuit (basic module only)

### Electrical characteristics

Power supply of the modules	12 - 18 volts direct or alternating voltage Note: HADES provides the current for switching the entry turnouts. The power supply must therefore be matched to the nominal size and the type of turnout.
<div style="border: 1px solid black; padding: 5px; width: fit-content; margin: auto;">  The modules must <b>not</b> be supplied via a transformer that is also used as an analogue driving current transformer or to supply the digital system! For further information → 2.8. "Power supply"         </div>	
Supply of the tracks in the staging yard	via the analogue driving transformer or the digital track voltage
Current consumption of the circuit	approx. 60 mA (without external consumers such as turnouts, LEDs, buttons)
Maximum output current	3,000 mA per siding



## Configuration

Number of sidings	2 ... 32 Per module controlling and monitoring of 2 sidings each Odd number of sidings possible through corresponding configuration of the last track module
Operating modes	First-in-First-out, random control or manual control
Extension time	2 to 20 seconds (adjustable in 1 second steps) Value on delivery: 5 seconds
Safety measure in case of full occupancy	Transit track or Stopping section at the entrance to the staging yard

## Protection

Protection class	Ready-made module (without housing): IP 00 Meaning: No protection against foreign bodies, contact and water.  Ready device (in housing): IP 20 Meaning: Protected against solid foreign bodies with diameter $\geq 12.5$ mm and access with a finger. No protection against water.
------------------	--

## Environment

	For use in closed rooms
Ambient temperature during operation	0 ~ + 30 °C
Permissible relative humidity during operation	10 ~ 85% (non-condensing)
Ambient temperature during storage	- 10 ~ + 40 °C
Permissible relative humidity during storage	10 ~ 85% (non-condensing)

## Other features

Dimensions (approx.)	Circuit board: 74 x 105 mm Ready device including housing: 100 x 112 x 35 mm
Weight (approx.)	Assembled board (ready-made module): 65 g Ready device including housing: 110 g

## 8. Warranty, EU conformity & WEEE

### 8.1. Guarantee bond

For this product we issue voluntarily a guarantee of 2 years from the date of purchase by the first customer, but in maximum 3 years after the end of series production. The first customer is the consumer first purchasing the product from us, a dealer or another natural or juristic person reselling or mounting the product on the basis of self-employment. The guarantee exists supplementary to the legal warranty of merchantability due to the consumer by the seller.

The warranty includes the free correction of faults which can be proved to be due to material failure or factory flaw. With kits we guarantee the completeness and quality of the components as well as the function of the parts according to the parameters in not mounted state. We guarantee the adherence to the technical specifications when the kit has been assembled and the ready-built circuit connected according to the manual and when start and mode of operation follow the instructions.

We retain the right to repair, make improvements, to deliver spares or to return the purchase price. Other claims are excluded. Claims for secondary damages or product liability consist only according to legal requirements.

Condition for this guarantee to be valid, is the adherence to the manual. In addition, the guarantee claim is excluded in the following cases:

- if arbitrary changes in the circuit are made,
- if repair attempts have failed with a ready-made module or device,
- if damaged by other persons,
- if damaged by faulty operation or by careless use or abuse.

## 8.2. EU Declaration of Conformity

 This product fulfils the requirements of the following EU directives and therefore bears the CE marking.

2001/95/EU Product Safety Directive

2015/863/EU on the restriction of the use of certain hazardous substances in electrical and electronic equipment (RoHS)

2014/30/EU on electromagnetic compatibility (EMC Directive). Underlying standards:

DIN-EN 55014-1 and 55014-2: Electromagnetic compatibility - Requirements for household appliances, electric tools and similar electrical appliances. Part 1: Emitted interference, Part 2: Immunity to interference

To maintain electromagnetic compatibility during operation, observe the following measures:  
Only connect the supply transformer to a professionally installed and fused earthed socket.  
Do not make any changes to the original components and follow the instructions, connection and assembly diagrams in this manual exactly.  
Only use original spare parts for repair work.

## 8.3. Declarations on the WEEE Directive

This product is subject to the requirements of the EU Directive 2012/19/EC on Waste Electrical and Electronic Equipment (WEEE), i.e. the manufacturer, distributor or seller of the product must contribute to the proper disposal and treatment of waste equipment in accordance with EU and national law. This obligation includes

- registration with the registering authorities ("registers") in the country where WEEE is distributed or sold
- the regular reporting of the amount of EEE sold
- the organisation or financing of collection, treatment, recycling and recovery of the products
- for distributors, the establishment of a take-back service where customers can return WEEE free of charge
- for producers, compliance with the Restriction of the Use of Certain Hazardous Substances in Electrical and Electronic Equipment (RoHS) Directive.



The "crossed-out wheeled bin" symbol means that you are legally obliged to recycle the marked equipment at the end of its life. The appliances must not be disposed of with (unsorted) household waste or packaging waste. Dispose of the appliances at special collection and return points, e.g. at recycling centres or at dealers who offer a corresponding take-back service.

Further Information and Tips:

<http://www.tams-online.de>

Warranty and Service:

Tams Elektronik GmbH

Fuhrberger Straße 4  
DE-30625 Hannover

fon: +49 (0)511 / 55 60 60

fax: +49 (0)511 / 55 61 61

e-mail: [modellbahn@tams-online.de](mailto:modellbahn@tams-online.de)

